



Prepared for:

City of Lincoln
Lincoln, Nebraska



Parking Structure Design Guidelines

Carl Walker
Parking
Planning Engineering Restoration

Ideas for parking. SOLUTIONS FOR PEOPLE®



Prepared by:

Carl Walker, Inc.
950 West Elliott Rd., Suite 107
Tempe, AZ 85284

PARKING STRUCTURE DESIGN GUIDELINES

Introduction

This document was developed for the City of Lincoln as a guide for future parking structure design in Downtown Lincoln. It contains information to help developers and designers incorporate parking structure components into proposed projects. The concepts presented will help produce functional, well-designed and patron friendly parking structures that will become valued infrastructure elements for the Downtown. The concepts are presented so that common design mistakes can be avoided by being addressed early in the design process. The document is based on *Carl Walker's* internal *Guidelines for Functional Parking Design* and should be periodically updated to reflect state-of-the-art parking design practices and principles. It includes the following categories:

- Project Delivery
- Sustainable Design - LEED
- Site Requirements
- Site Constraints
- Concept Design
- Circulation and Ramping
- Access Design
- Parking Geometrics
- Parking Layout Efficiency
- Vehicular Entry / Exit Lanes
- Pedestrian Requirements
- Accessible Parking Requirements
- Safety and Security
- Lighting
- Signage and Wayfinding
- Drainage
- Open or Enclosed Parking Structures
- Structural Systems
- Durability Design
- Other Considerations

In any future parking development project it is highly recommended that qualified parking structure design specialty firm be engaged to lead the project due to the unique characteristics and design expertise required to develop a successful project.



PARKING STRUCTURE DESIGN GUIDELINES

Project Delivery

There are four primary project delivery methods commonly used to design and construct parking structures. Two Design Professional's Handbooks titled the *Design-Build Project Delivery* and the *Design/Contract-Build Project Delivery*, published by the American Council of Engineering Companies (ACEC), are helpful references.

Each method is described on the following pages, along with a graphical depiction of the contractual relationships for each:

1. [Design-Bid-Build](#) (D-B-B) projects are those where the owner selects and contracts with the lead designer (Parking Consultant or Architect/Engineer). They in turn represent the owner in defining the project and preparing drawings and specifications to meet the owner's needs for competitive bidding to contractors. Often on public projects the owner is required to select the lowest "responsive and responsible" bid, with the contractors' qualifications often not given consideration. The D-B-B method is sometimes referred to as the "traditional" process and is still the most common method.
2. [Design-Bid-Build](#) with a Construction Manager (CM) is where the owner selects and contracts with the A/E who represents the owner in defining the project and preparing drawings and specifications to meet the owner's needs for bidding. However, the owner also retains a construction manager (CM) who works with the A/E during the design phases, sets the project schedule, and performs construction cost estimates. The CM bids the work to subcontractors for the various trades. This is a better method than D-B-B for projects where the owner wants fast track or phased construction.

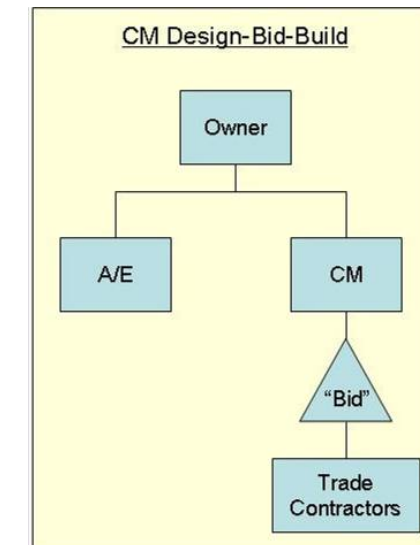
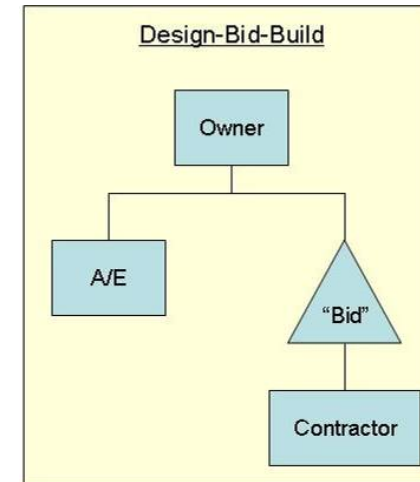

PARKING STRUCTURE DESIGN GUIDELINES

3. Design-Build (D-B). In this case, the owner retains a D-B contractor who in turn retains the A/E so there is a single entity responsible for both design and construction. Often the owner prepares or retains another A/E to prepare design build criteria documents as described below. Often, the owner can select the D-B team based on qualifications and cost, consistent with the bidding documents. There has been more interest in D-B type projects recently because of owners who perceive benefits regarding cost, schedule, and risk management.
4. Design-Contract-Build (D-C-B) are projects where the owner selects and contracts with the A/E. The A/E prepares preliminary documents that are the basis for the owner contracting with the contractor early in the design process, rather than waiting for final design documents to be prepared as for D-B-B. This method combines the advantages of the D-B-B and D-B methods while reducing many disadvantages to allow the owner to have the most qualified A/E and contractor involved in their project from the design phase through the completion of construction.

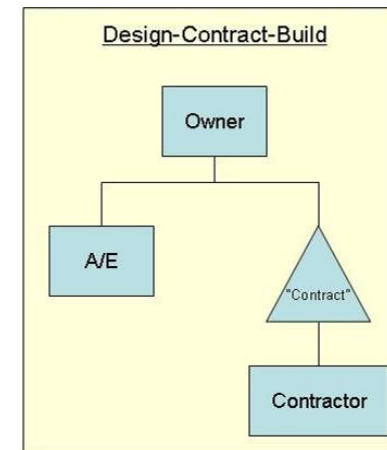
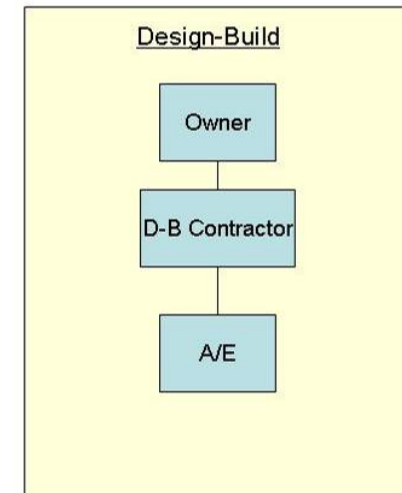

PARKING STRUCTURE DESIGN GUIDELINES

In recent years there has been an increasing interest and use of Design-Build in the construction of parking structures. Legislation has been enacted in many states to allow D-B to be used by public entities because prior laws required publicly funded construction contracts to be awarded based upon completed design documents.

Advantages of Design Build:

- Owner has a single point of responsibility for design and construction.
- Potential for better design and construction coordination because the A/E is working for the contractor.
- Owner does not have to arbitrate disputes between the A/E and contractor.
- Owner reduces their risk because the D/B contractor is responsible for errors or omissions in the design documents.
- Could be less administrative burden on the owner.
- Potential for accelerated schedule because the contractor is onboard at the beginning and because of the overlapping of design and construction work.
- Potential for lower costs due to the contractor being in greater control of the project and due to the accelerated schedule.
- Costs are well defined earlier in the process

Disadvantages of Design Build:

- The D-B contractor has the incentive to complete projects faster and less expensively which can mean reduced quality of materials and workmanship.
- The owner has less involvement and control of the design because the A/E represents the D-B contractor's best interests, not the owner's. Not only is this a disadvantage for the owner, but it creates a difficult conflict of interest for the A/E.
- The owner does not benefit from independent advice and input from the A/E and contractor.
- Greater definition of the project is required up front to define goals, objectives, and minimum requirements for project function, appearance, quality, materials, operation, etc. prior to bidding to D-B teams.
- More risk for D-B teams, which can negate the potential cost saving opportunities.

PARKING STRUCTURE DESIGN GUIDELINES

When owners decide that D-B is right for their project, they can have a better chance of achieving a successful project utilizing the following procedures.

Recommendations Regarding the Design-Build Delivery Method:

1. The owner should retain an A/E at project initiation to prepare the D-B criteria documents. This allows the owner to have more input into the concept design and set standards and criteria for the project. Also, due to the uniqueness of parking structures, it is important to have the A/E led by a parking consultant or for a parking consultant to have a significant role on the design team.
2. D-B criteria documents should clearly define the project scope, function, appearance, quality, materials, and operations. The level of completeness of these documents varies, but generally they are in the 10 to 30 percent range (between Schematic Design and Design Development level of completeness).
3. The owner should use a very transparent selection process to hire the D-B contractor, using the D-B criteria documents as the basis of the Request for Qualifications/Proposals (RFQ/RFP).
4. The selection process should consider the D-B teams' technical qualifications and experience in addition to cost. Typically there is a weighting of selection criteria such as the experience and expertise of the firms and key personnel making up the team, experience of the team working together, technical merits of design, project appearance, quality and safety programs of the contractor, references, schedule, and cost. The selection criteria and weighting should be defined in the RFQ/RFP.



Parking structure built using the Design-Build delivery method for Baylor University.

PARKING STRUCTURE DESIGN GUIDELINES

5. The owner's A/E who prepared the D-B criteria documents should continue on during the final design and construction to represent the owner's interest and help assure that the design and construction are completed in conformance with the D-B criteria documents.

As an alternative to using the D-B method, the D-C-B or CM methods can often result in a project that meets the owner's best interests because:

- o The A/E contracts to the owner, thus representing their interests, not the contractors, which should enhance quality
- o Design decisions can more easily be made that are in the best long-term interest of the owner, considering factors that will provide the lowest life cycle maintenance or operational cost, rather than emphasizing those that just provide the lowest first cost or schedule advantage
- o The CM or contractor is onboard early in the design process so the A/E and contractor collaborate during design, enhancing innovation and opportunities to consider the contractor's cost saving ideas
- o Similar schedule and cost advantages compared to D-B.
- o Less risk for all parties as responsibilities can be allocated where they most belong

Successful parking structure projects have been completed using all four of the construction methods discussed above. Understanding the advantages and disadvantages of each and following a process to address them will help assure that the completed project is a success for the user, owner, community, designer and builder.

PARKING STRUCTURE DESIGN GUIDELINES

Sustainable Design – LEED Accreditation

While it is possible for parking structures to achieve certification, typically only occupied buildings receive certification for their sustainable design through the U.S. Green Building Councils (USGBC) Leadership in Energy and Environmental Design (LEED) accreditation program. However, parking structures that are part of a mixed use project can help attain LEED points for the entire building project. The fact that stand-alone parking structures are generally not LEED certified should not discourage including sustainable design elements in parking structures. Examples of sustainable design features for parking structures include:

- Solar panel sunshades on the top levels that generate electricity.
- Energy efficient light sources such as fluorescent, induction, and light emitting diodes (LED).
- VOC – compliant waterproofing materials.
- Bicycle storage lockers.
- Recycled materials such as silica fume, fly ash, and steel.
- Green-roof waterproofing systems and vegetation materials.
- Interior light wells to lighting and ventilation energy consumption.



PARKING STRUCTURE DESIGN GUIDELINES

Site Requirements

Large and rectangular shaped sites are ideal for parking structures. Although flat sites are generally more economical to develop, sloped sites can provide design opportunities such as access on different levels and/or no ramping between levels. For a reasonably efficient parking layout, double-loaded parking “bays” range in width from about 54 to 60 feet, depending upon the angle of parking and the width of the parking space. The overall width of the structure should be determined based upon multiples of the chosen parking bay width. An ideal length for a parking structure is at least 240 feet. Longer sites provide the opportunity to park along the end bays, which provides more parking spaces, improves efficiency, and lowers the cost per space. A longer site also allows for shallower ramps which provide improved user comfort.

Generally, parking bays should be oriented parallel to the longer dimension of the site and preferably in the predominate direction of pedestrian travel. Walking distance tolerances from parking to a primary destination are typically 200 to 300 feet for shoppers, 500 to 800 feet for downtown employees, and 1,500 to 2,000 feet for special event patrons and students.

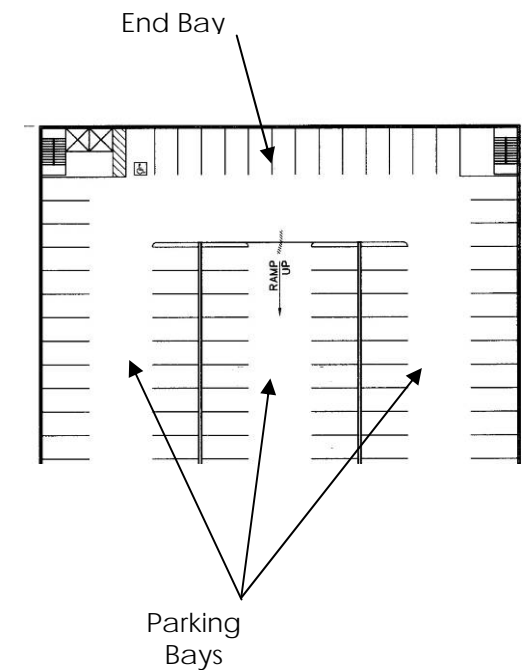

PARKING STRUCTURE DESIGN GUIDELINES

Site Constraints

Other site issues to be considered when evaluating a potential site for a suitable parking facility include the following:

- Site Survey – a topographic survey of the site is a very important precursor to develop a conceptual plan. The site survey should delineate property lines, easements, and utility lines.
- Site Slope – The topographic information will define the slope of the site. Sometimes the slope of a site can be used to reduce internal ramping in a parking structure, resulting in significantly lower costs. A parking structure that is built into a hillside can also reduce the visual mass of the facility.
- Geotechnical & Soils – Obtaining a soils report with sample borings and a geotechnical analysis early in the design process is prudent. If soils with poor bearing capacity are present on the site, the added cost for structural foundations can be significant.
- Codes and Ordinances – Municipal ordinances often specify setbacks, building height and bulk limitations, floor area ratio to site area, etc. that can significantly affect the allowable area on a site for a parking structure. The local planning organization may also impose development guidelines that must be followed.

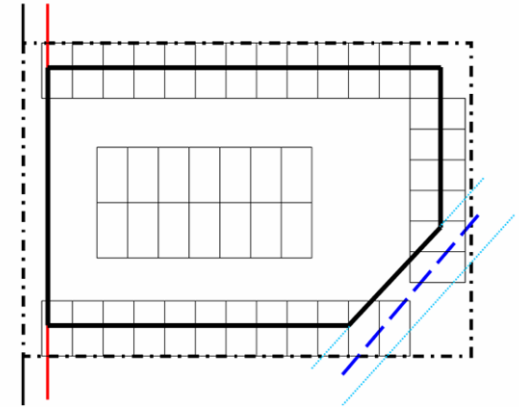

PARKING STRUCTURE DESIGN GUIDELINES

Concept Design

Much of the remainder of these guidelines addresses issues and elements of parking structures that should be considerations during the conceptual design phase.

Parking Structures for People

An overall design principal to keep in mind is that parking structures are for people. Designing to accommodate the users of a particular structure will help produce a better parking structure.

- Different user types will have different needs
- Some user types may need to be physically separated to ensure revenue control or for security reasons.
- Different users require different pedestrian circulation systems
- Parking space widths and circulation geometry needs vary depending on the user type.
- Some vehicular circulation system are better for specific user types:
 - Residential – Regular users enter and exit two times a day.
 - Education – May have peak loads in and out.
 - Hotel – Overnight guests, maybe event parking too.
 - Office – Low turnover. Regular users enter and exit two times a day.
 - Health Care Visitors –Wayfinding very important. Need to accommodate elderly drivers and passengers.
 - Health Care Staff – Shift time overlap and loading. Security issues at particularly at night.



PARKING STRUCTURE DESIGN GUIDELINES

- o Retail – High turnover. Occasional users - wayfinding to and from vehicle.
- o Elderly or Families with Small Children – Wayfinding again important. May need larger spaces and more elevators.
- o Events – Easy quick loading and unloading of structure. Multiple vehicular paths. Consider revenue collection method – typically flat fee on entry. Provide queuing space. Consider pedestrian flow to event - avoid crossing traffic.

PARKING STRUCTURE DESIGN GUIDELINES

Circulation and Ramping

The basic circulation element for a parking structure is the continuous ramp with parking on both sides of the drive aisle. In continuous ramp structures, some of the parking floors are sloped in order for traffic to circulate from one level to another. Only on a sloping site that permits direct access to each level from the exterior roadways are ramps unnecessary; but they still may be desirable for internal circulation.

The basic criteria for choosing a circulation system are the simplicity or complexity of the system and the architectural compatibility. Ingress and egress capacities are also a consideration in the selection of a circulation system. Some circulation systems provide the opportunity for level façades which may be desirable.

A parking ramp slope of 5% or less is preferred, although parking ramp slopes up to 7% are tolerated by the public in very dense urban areas. Parking ramp slopes should not exceed a 6.67% slope, which is the maximum parking slope permitted in the International Building Code (IBC).

PARKING STRUCTURE DESIGN GUIDELINES

Non-parking ramps are often employed at airports, casinos, large retail structures, for special event structures, and on small and irregularly shaped sites. Non-parking ramps consist of circular helixes (most common), express ramps (external), and speed ramps (internal). Non-parking ramp slopes should have a maximum slope in the 12% to 14% range. Non-parking ramp slopes up to 20% are sometimes considered if covered or equipped with snow melt systems.

Parking structures with non-parking ramps tend to be less efficient in terms of square feet of structure per parking space which directly increases the construction cost per parking space.

A grade difference of 8% or more requires transition slopes so vehicles do not bottom out. Recommended are minimum 10'-0" transition slopes at the top and bottom of the ramp that are one-half of the differential slope. For instance, two 10'-0" transition ramps sloped at 6.25% would be required at the bottom and the top of a ramp sloped at 12.5%.

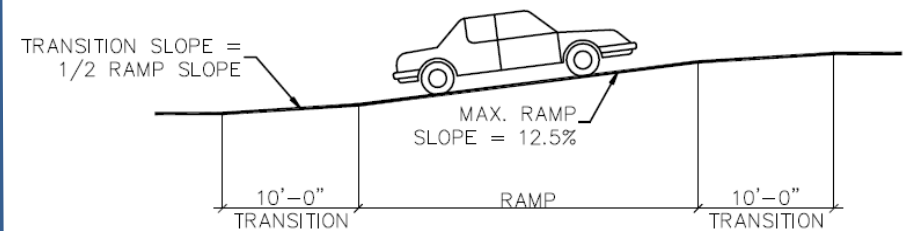
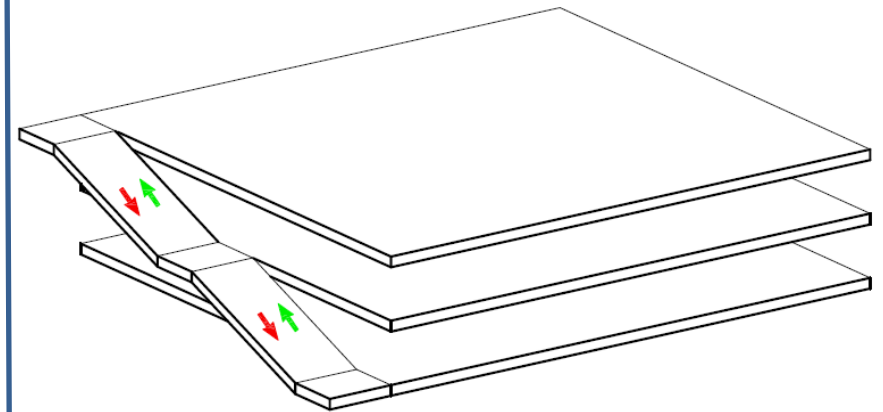

PARKING STRUCTURE DESIGN GUIDELINES

One-Way vs. Two-Way Traffic

One of the primary factors in the design of parking structure is determining the traffic flow; one-way or two-way. Typically, a parking bay for a one-way traffic flow is narrower than for a two-way flow. The available site dimensions will influence the parking bay width and thus also influence the circulation pattern. There are advantages and disadvantages to both circulation patterns. One-way traffic flow should never be combined with 90° parking. In parking facilities with one-way traffic flow, the angle of the parking stalls establishes the direction of vehicle traffic.

Advantages of One-Way Traffic Flow:

- Easier for parkers to enter/exit parking spaces.
- Vehicles are more likely to be centered in angled spaces.
- Less circulation conflict and reduced potential for accidents.
- Better visibility when backing out of a stall.
- Separation of inbound and outbound traffic and improved flow capacity of the circulation system.
- The intended traffic flow is self-enforcing.
- One-way traffic allows the angle of parking to be changed to accommodate changes in vehicle sizes.

Advantages of Two-Way Traffic Flow:

- Wider drive aisles allow parkers to pass other vehicles.
- Wider drive aisles are safer for pedestrians.
- Better angle of visibility when searching for a parking space.
- Traffic flow follows its own pattern rather than one that is forced.
- Two-way traffic and 90° parking makes more efficient use of parking aisles (more spaces in a run).
- Two-way parking facilities can essentially operate as one-way facilities when there is heavy directional traffic.

PARKING STRUCTURE DESIGN GUIDELINES

Single Threaded Design

In order to develop a reasonably efficient free-standing parking structure, the **minimum** dimensions needed are about 122 feet in width by 155 feet in length. A width of 122 feet allows for a two-bay facility with two-way traffic flow and 90-degree parking. A facility with two-way traffic and a five-foot rise along each bay requires approximately 155 feet in length for a minimum floor-to-floor height of about ten feet. That is, one 360-degree turn within the facility equates to a vertical rise of ten feet. A structure in this configuration has sloping floors along both façade sides. However, sloping floors can make façade treatments challenging. On larger sites that allow a structure length of about 255 feet, one bay can be sloped rising 10 feet with opposite façade having a "level" floor.

Because of the number of 360° turns needed to ascend in a single threaded structure, the number of levels (floors) should preferably be limited to a maximum of six, otherwise the number of turns required and the number of spaces passed becomes inconvenient. A structure with a two-bay single thread design has a capacity for a maximum of approximately 750 spaces. The isometric diagram to the right represents a two-bay single-threaded helix.

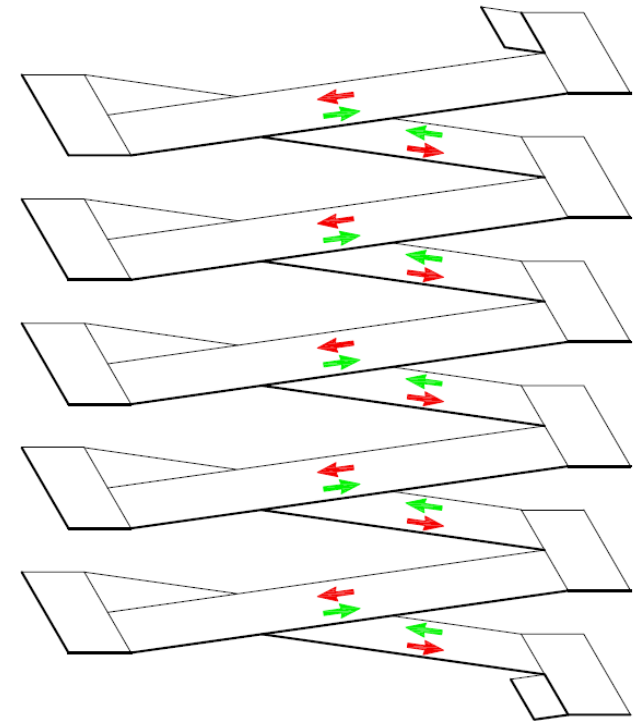

Single Threaded Helix with Sloping Floors

PARKING STRUCTURE DESIGN GUIDELINES

Principal Advantages of a Single-Threaded Helix:

- Repetitive and easy to understand for users.
- Potentially more flat-floor parking and level façade elements.
- Better visibility across the structure, which enhances security.

Principal Disadvantages of a Single-Threaded Helix:

- More revolutions required going from bottom to top and top to bottom.
- Two-way traffic bays have less flow capacity than one-way traffic bays. Traffic in both directions is impeded by vehicles parking and vacating a space.

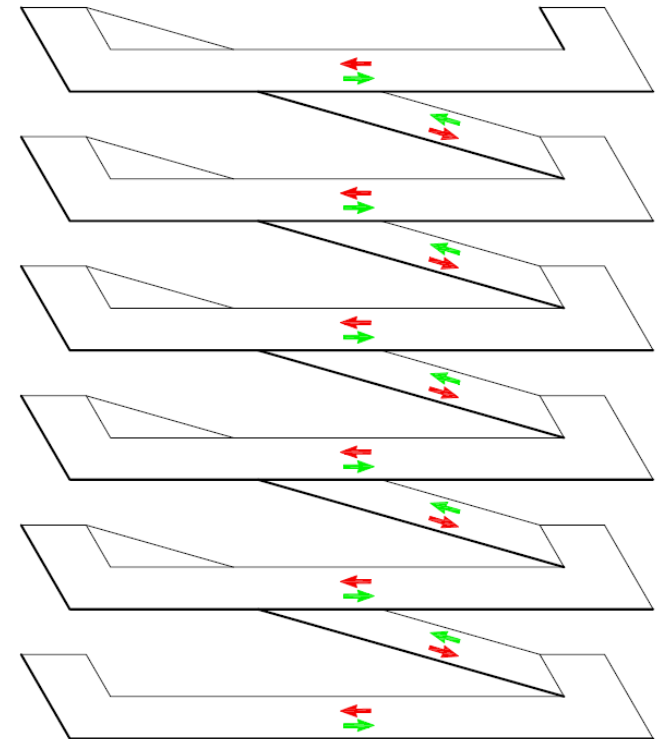

Single Threaded Helix with One Level Bay

PARKING STRUCTURE DESIGN GUIDELINES

Double Threaded Design

A facility with a one-way circulation system and angled parking can be provided in a double-threaded helix with modules ranging from 54 to 58 feet in width, depending upon the angle of parking. The preferred angles of parking for an efficient layout are 60°, 70° and 75°. A double thread, which requires a ten-foot rise along each module, requires 240 feet in length. More efficient layouts can be achieved on longer sites. The isometric right represents a two-bay double-threaded helix with one-way traffic.

A double-threaded helix can work with either one-way or two-way traffic flow, although one-way traffic is more common. A two-way double threaded design can be configured as two separate structures with no vehicular connection. A double-threaded helix rises two levels with every 360 degrees of revolution, which allows for two intertwined "threads" and the opportunity to circulate to an available parking space without passing all parking spaces as inbound and outbound traffic can be separated. Because of this, double-threaded helices are often recommended for larger facilities with seven or more levels. A two-bay double thread has a functional system capacity for up to approximately 2,000 spaces with angled parking and one-way traffic flow.

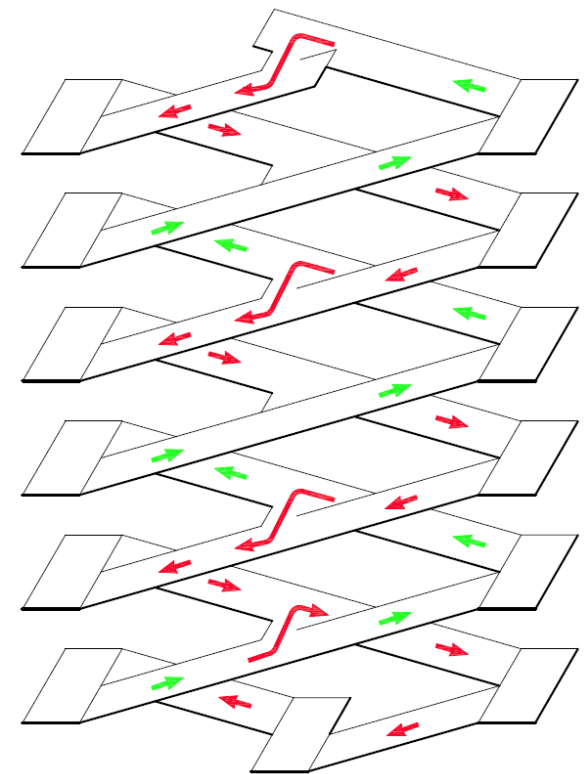

One Way Double Threaded Design

PARKING STRUCTURE DESIGN GUIDELINES

Principal Advantages of a Double-Threaded Helix:

- Efficient circulation and more traffic flow capacity
- Pass fewer spaces both inbound and outbound.

Principal Disadvantages of a Double-Threaded Helix:

- Can be complex and confusing, particularly in finding one's vehicle upon return to the parking facility.
- Two-sloped bays and minimal flat-floor parking.

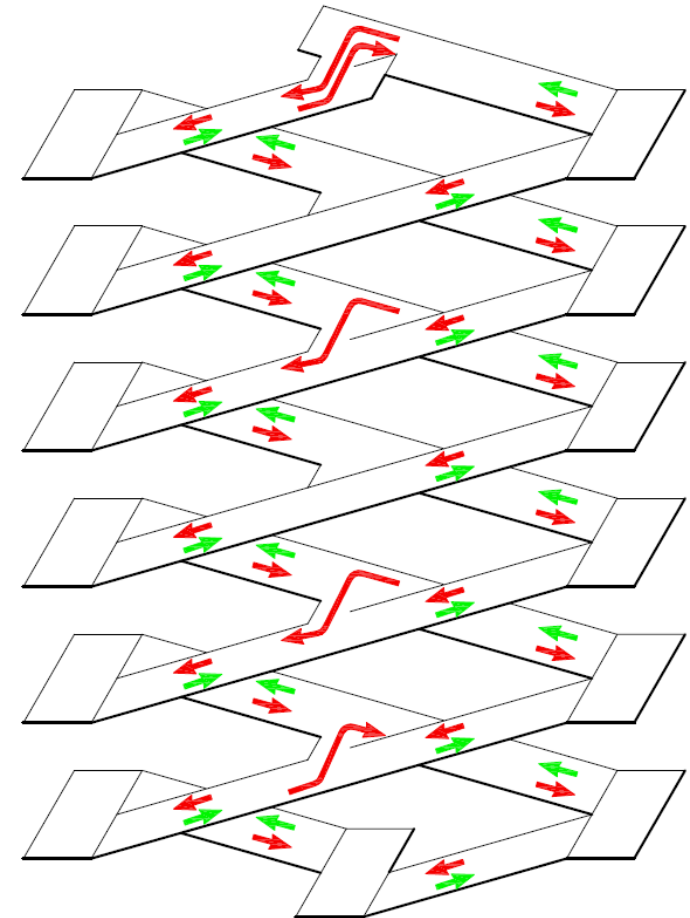

Two Way Double Threaded Design

PARKING STRUCTURE DESIGN GUIDELINES

Other Circulation Systems

There are other parking and circulation systems that are often used in parking structures.

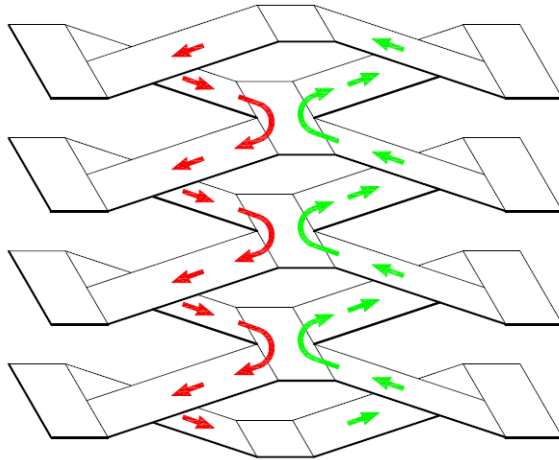

End-to-End Helix Both Bays Sloped

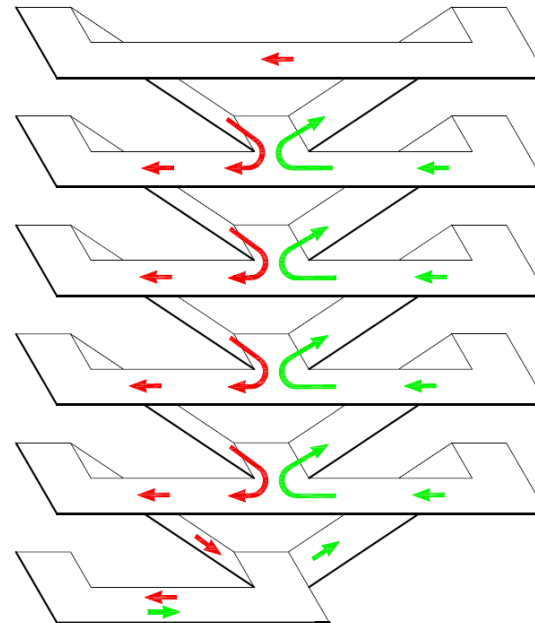

End-to-End Helix One Bay Sloped

PARKING STRUCTURE DESIGN GUIDELINES

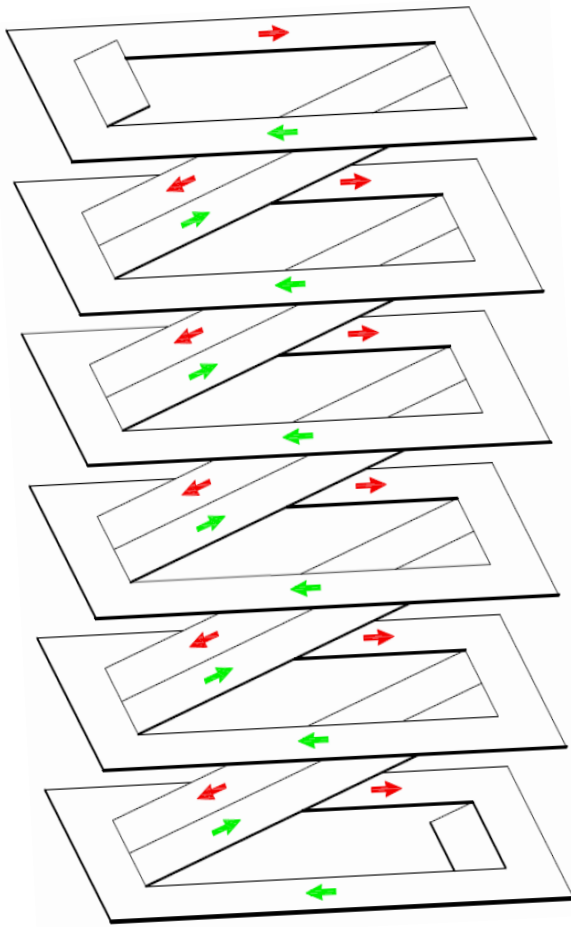

Side-by-Side Helix

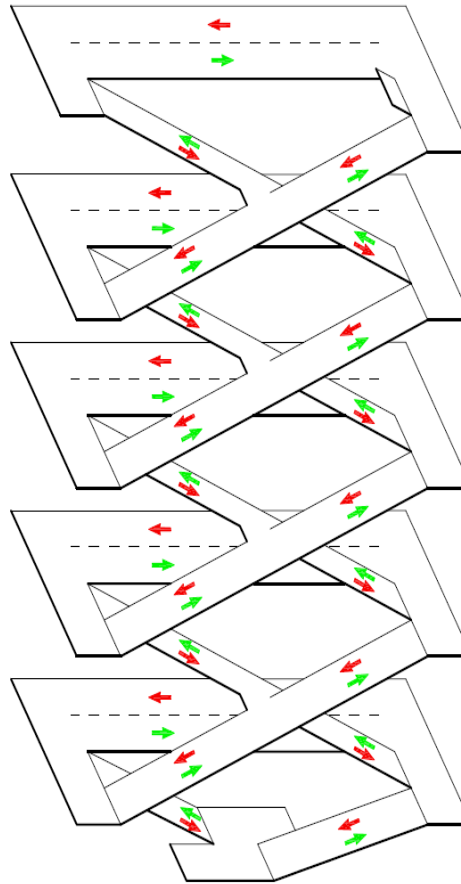

Single Threaded w/ Flat Bays

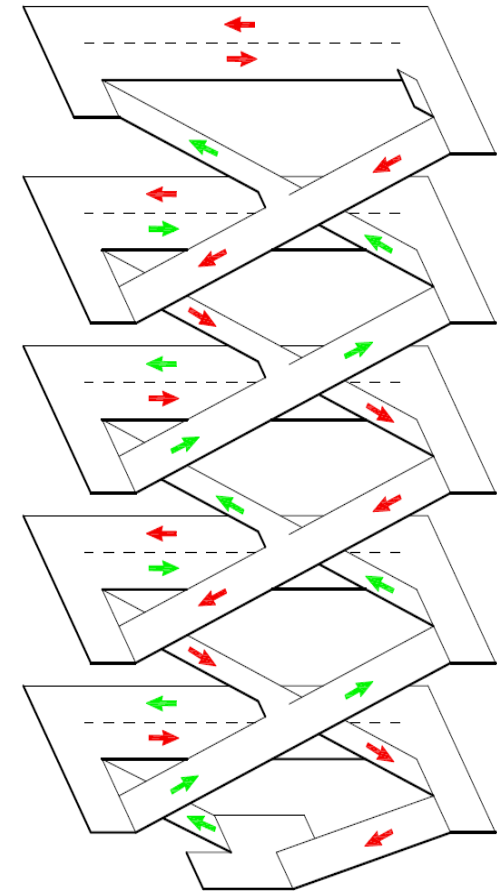

Double Threaded w/ Flat Bays

PARKING STRUCTURE DESIGN GUIDELINES

Access Design

Vehicle entrances should be visible and easily identifiable. The minimum distance of entry/exits from corner intersections is at least 75 to 100 feet (preferably 150 feet). Entrances and exits should have clear lines of sight. It is preferable to enter a facility from a one-way street or by turning right from a two-way street and to exit a facility by turning right on a low-volume street. High traffic volumes and left turns can slow exiting and cause traffic backups. Consideration should be given to acceleration/deceleration lanes on busy streets. Gates should be located far enough away from the street to allow at least one vehicle behind the vehicle in the service position (at a ticket dispenser, card reader or cashier booth) without blocking the sidewalk. Entry/exit areas that have parking control equipment should have a maximum 3% slope.

It is very important to provide the appropriate number of entry/exit lanes to meet projected peak traffic volumes. The number of lanes is a function of user groups served, peak-hour traffic volumes, and service rates of the parking control equipment. It is recommended to have a parking professional prepare a lane and queuing analysis to guarantee sufficient entry and exit capacities.

Cross-traffic at entry/exits should be minimized and preferably eliminated. When placing vehicle entries and exits together on one-way streets it is preferable to avoid "English" traffic conditions where traffic keeps to the left instead of to the right. Pedestrian/vehicular conflicts should be minimized by providing a pedestrian walkway adjacent to entry/exit lanes. Stair/elevator towers should be located so pedestrians do not have to cross drive aisles on their way to primary demand generators.

PARKING STRUCTURE DESIGN GUIDELINES

Parking Geometrics

Parking geometrics refers to parking stall and drive aisle dimensions. Parking dimensions have been developed to comfortably accommodate the composite design vehicle, which refers to the dimensions of the 85th percentile vehicle in the range of vehicles from smallest (zero percentile) to largest (100th percentile). The composite design vehicle is the size of a Ford F150 truck (6'-7" x 17'-3").

The table on this page lists City of Lincoln parking geometrics by parking angle for standard and compact spaces.

Parking Angle	Stall Width	Curb Length Per Car	Stall Depth	Driveway Width
A	B	C	D	E
0°	9'- 0"	23'- 0"	9'- 0"	12'- 0"
20°	9'- 0"	26'- 4"	15'- 3"	11'- 0"
30°	9'- 0"	18'- 0"	17'- 8"	11'- 0"
40°	9'- 0"	14'- 0"	19'- 6"	12'- 0"
45°	9'- 0"	12'- 9"	20'- 5"	13'- 0"
50°	9'- 0"	11'- 9"	21'- 0"	14'- 0"
60°	9'- 0"	10'- 5"	21'- 10"	16'- 0"
70°	9'- 0"	9'- 8"	21'- 10"	18'- 0"
80°	9'- 0"	9'- 2"	21'- 4"	20'- 0"
90°	9'- 0"	9'- 0"	20'- 0"	22'- 0"

MINIMUM STANDARDS FOR COMPACT VEHICLES

Parking Angle	Stall Width	Curb Length Per Car	Stall Depth	Driveway Width
A	B	C	D	E
45°	7'- 6"	10'- 6"	16'- 0"	11'- 0"
60°	7'- 6"	8'- 9"	16'- 9"	14'- 0"
75°	7'- 6"	7'- 10"	16'- 4"	17'- 5"
90°	7'- 6"	7'- 6"	15'- 0"	20'- 0"

PARKING STRUCTURE DESIGN GUIDELINES

The city's parking dimensions for standard spaces exceed industry standards. The table on the following page lists parking geometrics by User Comfort Factor (UCF) which correlates with a Level of Service (LOS) approach. Traffic engineers developed the LOS approach to classify traffic conditions on roadways from A (free flow) to F (gridlock). The UCF/LOS approach has been adopted by many parking consultants to help classify conditions in parking facilities. The UCF categories for parking geometrics are as follows:

- UCF 4 = LOS A = Excellent
- UCF 3 = LOS B = Good
- UCF 2 = LOS C = Acceptable
- UCF 1 = LOS D = Poor

LOS criteria should be related to the needs and concerns of users. Generally, users with low familiarity and high turnover should be accorded a higher UCF. If the city's parking standards are not used, we recommend minimum UCF 3 geometrics for moderate to high turnover parking (visitor, retail, etc.) and UCF 2 geometrics for low turnover parking (employee, commuter, resident, etc.).

We recommend using "one-size-fits-all" parking spaces rather than segregating standard and small car spaces. However, if they are used, small car spaces should not exceed 15% to 20% of the total capacity of a facility.

PARKING STRUCTURE DESIGN GUIDELINES

Parking Layout Dimensions

PARKING LAYOUT DIMENSIONS

Stall Parking Angle	Width Projection (WP)	Module Width (1) (MW)	Vehicle Projection (VP)	Aisle Width (AW)
User Comfort Factor 4				
w = 9'-0"				
45	12'-9"	49'-10"	17'-7"	14'-8"
50	11'-9"	51'-7"	18'-2"	15'-3"
55	11'-0"	53'-0"	18'-8"	15'-8"
60	10'-5"	54'-6"	19'-0"	16'-6"
65	9'-11"	55'-9"	19'-2"	17'-5"
70	9'-7"	57'-0"	19'-3"	18'-6"
75	9'-4"	58'-0"	19'-1"	19'-10"
90	9'-0"	62'-0"	18'-0"	26'-0"
User Comfort Factor 3				
w = 8'-9"				
45	12'-4"	48'-10"	17'-7"	13'-8"
50	11'-5"	50'-7"	18'-2"	14'-3"
55	10'-8"	52'-0"	18'-8"	14'-8"
60	10'-1"	53'-6"	19'-0"	15'-6"
65	9'-8"	54'-9"	19'-2"	16'-5"
70	9'-4"	56'-0"	19'-3"	17'-6"
75	9'-1"	57'-0"	19'-1"	18'-10"
90	8'-9"	61'-0"	18'-0"	25'-0"

Stall Parking Angle	Width Projection (WP)	Module Width (1) (MW)	Vehicle Projection (VP)	Aisle Width (AW)
User Comfort Factor 2				
w = 8'-6"				
45	12'-0"	47'-10"	17'-7"	12'-8"
50	11'-1"	49'-7"	18'-2"	13'-3"
55	10'-5"	51'-0"	18'-8"	13'-8"
60	9'-10"	52'-6"	19'-0"	14'-6"
65	9'-5"	53'-9"	19'-2"	15'-5"
70	9'-1"	55'-0"	19'-3"	16'-6"
75	8'-10"	56'-0"	19'-1"	17'-10"
90	8'-6"	60'-0"	18'-0"	24'-0"
User Comfort Factor 1				
w = 8'-3"				
45	11'-8"	46'-10"	17'-7"	11'-8"
50	10'-9"	48'-7"	18'-2"	12'-3"
55	10'-1"	50'-0"	18'-8"	12'-8"
60	9'-6"	51'-6"	19'-0"	13'-6"
65	9'-1"	52'-9"	19'-2"	14'-5"
70	8'-9"	54'-0"	19'-3"	15'-6"
75	8'-6"	55'-0"	19'-1"	16'-10"
90	8'-3"	59'-0"	18'-0"	23'-0"

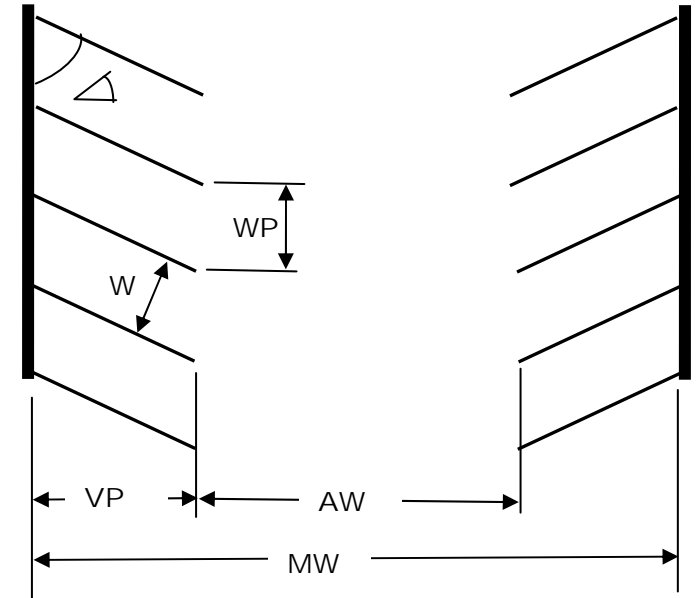

Note: (1) Wall to wall, double loaded aisle.

PARKING STRUCTURE DESIGN GUIDELINES

Parking spaces adjacent to walls, columns, elevators, stairs, etc. should be widened, if possible, by one foot so that vehicle doors can be more easily opened.

End bay drive aisles with two-way traffic should be a minimum of 26' wide for improved turning maneuverability. Wider end bay drive aisles are recommended for high turnover parking facilities. If possible, it is also suggested for more comfortable turns to hold back the first stall on either side of the turning bay. Small-Car-Only (SCO) spaces are also recommended at the ends of interior parking rows. It is very difficult to make a turn around only one row of parking. Refer to the following graphic.

Double stripes for space striping are recommended as they help parkers center their vehicles between stripes, maximizing the space between vehicles (refer to the graphic below). Also recommended is the use of traffic yellow paint for stall striping as yellow paint is more visible over time than white paint.

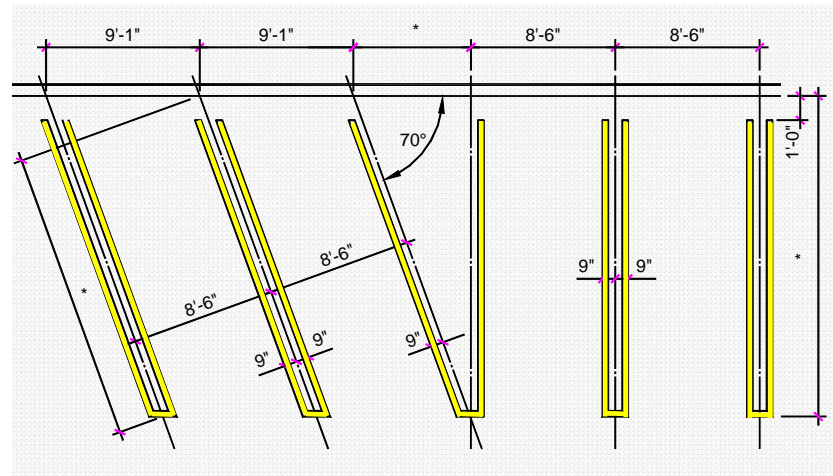
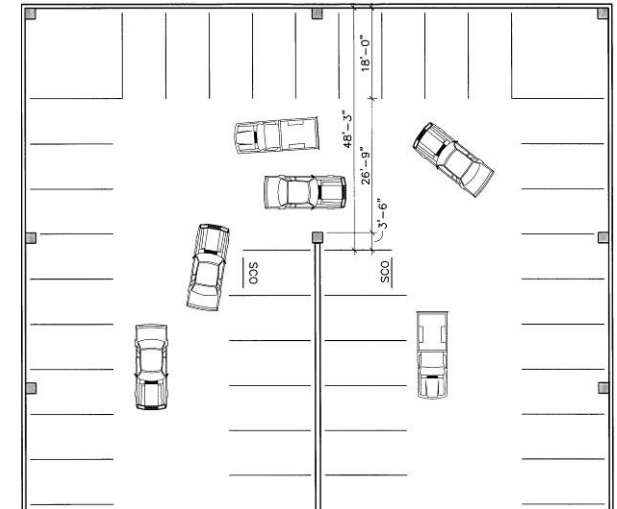

PARKING STRUCTURE DESIGN GUIDELINES

Parking Layout Efficiency

Parking Efficiency is expressed in square feet of construction per parking space. Parking efficiency directly correlates with the construction cost per space. Build less structure per space and the cost per space drops. Non-parking speed ramps for example increase the square feet per space.

Parking efficiency should be calculated considering the total parking structure size including the stairs and elevators and non-parking ramps. Any retail space that is incorporated within the structure is also usually included in the calculation.

Typical ranges of parking structure efficiencies are:

- Short Span Structural System = 330 to 390 Square Feet per Space
- Long Span Structural System = 300 to 340 Square Feet per Space
- Mixed Use Developments with retail, Residential and Parking can be as high as 400 + Square Feet per Space

PARKING EFFICIENCY MAKES A BIG DIFFERENCE – EXAMPLE

- $360 \text{ sf / space} \times 500 \text{ spaces} \times \$45 / \text{sf} = \$8,100,000$
- $330 \text{ sf / space} \times 500 \text{ spaces} \times \$45 / \text{sf} = \$7,425,000$

A difference of \$675,000 or \$1,350 per space!

PARKING STRUCTURE DESIGN GUIDELINES

Vehicular Entrance and Exit Lanes

- The number of entry and exit lanes depends on the expected peak volume of traffic and the rate of flow through the lane. The rate of flow varies depending on the type of access / revenue control equipment.
- The approach and the departure area from the lanes will also affect the rate of flow into or out of the structure. Tight turns equal a slower throughput.
- Pedestrian safety at entry and exit portals is paramount. Consider the vision cone of drivers entering or exiting the facility.
- Check and recheck with vehicle turning radii at all entry / exit lanes and adjacent ramps.

PARKING STRUCTURE DESIGN GUIDELINES

Pedestrian Requirements

Pedestrian traffic is equally as important in a parking structure as vehicle traffic. A safe, secure and well signed pedestrian path must be provided. Pedestrian access at the grade level should be separated from vehicular ingress and egress. Pedestrian access is usually adjacent to stair/elevator towers. It is also desirable to place a dedicated pedestrian aisle adjacent to a vehicle entry/exit because pedestrians are naturally attracted to these openings. Access locations should be restricted to a few locations for security reasons.

A minimum of two stairs are required to meet code-required means of egress for fire exits in parking structures. Stairs should be open or glass enclosed for security reasons. The minimum stair width in parking structures is 44" and wider stairs are required for special events. Travel distance between exit stairs is specified in the IBC and is maximum 300 feet without a sprinkler system and 400 feet with a sprinkler system. Stairs are usually placed in dead corners so no parking spaces are lost.

Elevators should be located at terminus in the direction of pedestrian travel. Hydraulic elevators can be used for up to 5 levels or 50' to 60'. Traction elevators should be used beyond 5 levels. The minimum capacity and size is 3,500 lbs. and 5'-0" x 7'-0". The number of elevators is based on the number of spaces, the number of levels, user group(s) served, peak-hour flow rates, and the size and capacity of the elevator. A parking consultant can provide a preliminary indication of the number of elevators based on a formula that takes into account the information presented above. Ornate or high maintenance elevator finishes are discouraged. **We highly recommend that elevators have glass backs for security reasons.** Enclosed lobbies are recommended for protection from the elements on the top level.

PARKING STRUCTURE DESIGN GUIDELINES

Accessible Parking Requirements

The following table presents the required number of accessible parking spaces based on the total number of spaces provided in any given facility.

The accessible parking requirement for an institution like a hospital campus is not based on the total parking capacity but rather on the capacities of the individual facilities within a parking system, which always results in the provision of more accessible spaces overall. Accessible spaces for the institution do not have to be provided in each parking area, but can be supplied at a different location provided at least equivalent accessibility in terms of distance, cost, and convenience is provided.

All accessible spaces are 8' wide with either a 5' or 8' access aisle. An accessible space and access aisle cannot be placed at a location with a running or cross slope greater than 1:50 (2%).

The current 1 to 8 ratio for the provision of van accessible spaces is changing to 1 to 6, and it is required to round up to the nearest whole number when determining the number of van spaces. The barrier free section of the International Building Code (IBC) has the same requirement. It is recommended to use the new 1 to 6 ratio when determining the number of van spaces. Van accessible spaces require minimum 8'-2" vertical clearance and have 8'-0" wide access aisles.

Each accessible space must have a sign showing the international symbol of accessibility mounted at least five feet above the pavement. All van accessible spaces must have an additional "Van Accessible" sign mounted below the symbol of accessibility (mount minimum of 5' above pavement with other sign above).

Required Accessible Spaces	
Total Spaces in Facility	Minimum Accessible Spaces
1 to 25	1
26 to 50	2
51 to 75	3
76 to 100	4
101 to 150	5
151 to 200	6
201 to 300	7
301 to 400	8
401 to 500	9
501 to 1,000	2% of total
1,001 and over	20 plus 1 for each 100 over 1,000

PARKING STRUCTURE DESIGN GUIDELINES

ADA requires rounding up to the next whole number when calculating the required number of spaces based on a percentage or ratio. For example, a parking facility with 810 spaces will have 17 accessible spaces ($810 \times .02 = 16.2 = 17$ spaces), and 3 spaces will have to be van accessible ($17 \div 8 = 2.125 = 3$).

Accessible stalls cannot share access aisles when the parking is angled. Access aisles for van spaces must be on the passenger side when the parking is angled because vehicles cannot back into these spaces.

All accessible spaces must have an accessible route to public streets or sidewalks, accessible elevators, or accessible building entrances. An accessible route must have a minimum unobstructed width of 3'. A vehicle way (drive aisle) may be part of an accessible route, although it is preferred to place the accessible route at the front of the stalls. An accessible route can only pass behind other accessible spaces. It is permitted to cross a vehicle way with an accessible route.

The running slope along an accessible route cannot exceed 1:20 (5%) and the cross slope cannot exceed 1:50 (2%).

It is recommended to cross hatch all access aisles and accessible routes.

PARKING STRUCTURE DESIGN GUIDELINES

Safety and Security

Because curbs can be a potential tripping hazard, curbs in all pedestrian areas (at the end of parking rows, around stairs and elevators, dead corners, etc.) are strongly discouraged. The faces and edge of curbs that remain should be painted traffic yellow to enhance visibility.

Glass-backed elevators and glass enclosed and/or open stairways for enhanced security are recommended.

Lighting that enables users to see and be seen is one of the most important security features of a parking structure. A separate discussion on lighting is included in these guidelines.

Other important aspects of security design:

- Short span construction is not recommended.
- Security fencing at the ground level should not be climbable.
- Landscaping should not provide hiding places.
- Security cameras are a deterrent to criminal activity.
- Panic alarms and two-way communication systems are recommended in prominent locations on each level.

In general, assure that as much openness as possible is provided in the design to improve sight lines, eliminate hiding places, and enhance perceived security.

PARKING STRUCTURE DESIGN GUIDELINES

Lighting

- Key Security Measure
- Enhances User Comfort & Perception of Safety
- Business Attraction Amenity
- Permit Safe Movement for Pedestrians and Vehicles
- Enhances Signage Visibility
- Typically Light Levels Are Not Code Regulated
 - Except Emergency Lighting @ 1 footcandles Minimum
- Industry Standards
 - Illuminating Engineering Society of North America (IESNA)
 - They Publish Minimum Standards
 - Liability Risk for Non-Compliance

The recommended lighting standards listed in the table below, slightly exceed the Illuminating Engineering Society of North America (IES) lighting standards for parking facilities. Staining the ceilings white to enhance light levels is suggested.

Recommended Parking Structure Lighting Standards			
Areas	Minimum Horizontal Illuminance on Floor Footcandles	Minimum Vertical Illuminance at 5 feet Footcandles	Maximum to Minimum Uniformity Ratio
General Parking & Pedestrian	2	1	10:1
Ramps and Corners			
Days	2	1	10:1
Nights	1	0.5	10:1
Entrance Areas			
Days	50	25	10:1
Nights	1	0.5	10:1
Stairways	7 avg.		10:1



PARKING STRUCTURE DESIGN GUIDELINES

Lighting Entry and Exit Lanes

- Provide Additional Lighting (50 fc) for 10' - 60' Zone From Building Edge (Transitional lighting)
- Include Daylight Infiltration (> 15 fc)
- Typically 10' X 10' Spacing of 150 W Fixtures
- Turn 2/3 of Fixtures Off @ Night

Light Source Types

- **High Pressure Sodium**
 - Golden White HPS Light Color
 - Common Parking Structure Lighting
 - Lamp Life = 24,000-28,500 Hours
- **Metal Halide**
 - White Light Color
 - Perceived Greater Brightness
 - Lamp Life = 15,000 Hours
 - Operating Cost Slightly > HPS
- **Light Emitting Diode (LED)**
 - Emerging Technology
 - Energy Efficient
 - Long Life
- **Fluorescent**
 - White Light Color
 - New Technology – Use in Cold Climates
 - Cold Weather Ballast (If Temps < 50° F)
 - Phosphor Coating
 - Sealed Fixtures
 - Lamp Life = 30,000 Hours
 - Energy Cost Effective
- **Induction Lighting**
 - White Light – Best color rendition
 - Instant Ignition Long Life Bulbs = 100,000 Hours
 - Energy Efficient
 - High Initial Costs

Lighting Expense Reduction Strategies

We recommend that the exterior bay lighting of “open” parking structures as well as roof top lighting be on separate circuits so that these lights can be turned off during the day to reduce energy consumption/costs as depicted in the lower picture on the right.

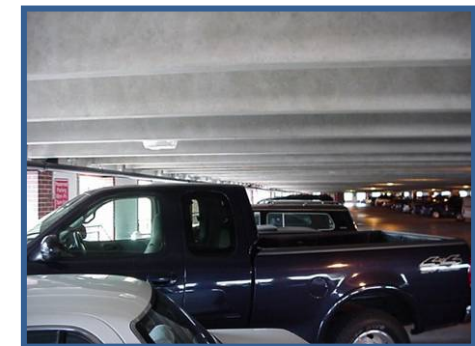

PARKING STRUCTURE DESIGN GUIDELINES



Before and after photographs showing the results of new lighting (high pressure sodium to metal halide) and staining of ceilings

PARKING STRUCTURE DESIGN GUIDELINES

Signage and Wayfinding

Parking facilities can be very large, complex, and confusing. A well-designed graphics and signage system will effectively communicate necessary information to patrons, reduce confusion, improve safety, and enhance the overall user experience.

Sign messages should be simple and succinct. Messages on signs that are to be read quickly, such as vehicular signs, should be no more than 30 characters and six words in length. The typeface used should be simple and easy to read, and there is a general preference for Helvetica medium in the parking industry. Signs with lower case letters and initial caps are most easily read. The simple block arrow is recommended for parking signs. If a left turn is required, the arrow should be placed on the left side of the sign. The opposite is true for a right turn.

In parking structures, signs with a dark background and white letters are more easily read than signs with a white background and dark letters. The opposite is true in surface lots, where signs with white background and dark letters are better.

Vehicle Signs

Examples of vehicular signs include "Park" and "Exit" directional signs. Vehicular signs are ten or twelve inches in height with six or seven inch letters. Ten-inch signs are recommended for precast structures where sign visibility can be a problem. Vehicular signs should be centered over the drive lane or centered over the drive aisle when signs are mounted back-to-back.



PARKING STRUCTURE DESIGN GUIDELINES

Pedestrian Signs

Examples of pedestrian signs include "Level #," "Remember Level #," "Row #," and "Stair" and "Elevator" identification and directional signs. Pedestrian signs can be all one color or be color-coded by level. Pedestrian signs should be clearly distinguishable from vehicle signs so as not to interfere with vehicular traffic. Pedestrian signs in parking bays are most effective if located perpendicular to traffic flow, and they should be placed at the rear of parking stalls. Color-coding is often used to help patrons find their vehicles. It is not necessary to provide color-coding in parking facilities that are three levels or less. When color coding, it is recommended to use primary and secondary colors including red, blue, yellow, orange, purple, and green. If there are more than six levels that need to be color-coded, it is recommended to use white, brown, and black. Confusing colors such as turquoise (blue or green?) and taupe (brown, tan, or gray?) should be avoided.

The elevator core area provides an excellent location to utilize super graphics. Super graphics is defined as a graphic that covers a large area and is generally painted on a vertical surface, such as painted walls or elevator doors, with level designation incorporated.



PARKING STRUCTURE DESIGN GUIDELINES

Level Theming

“Level Identification Theming” and other wayfinding aids provides an opportunity to enhance parking interior environment enhancement while also providing a practical tools to assist patrons in remembering where they parked. Several creative examples or illustrated below.

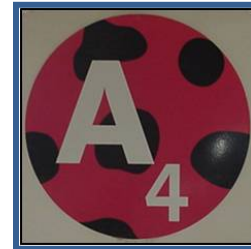

	10's
	20's
	30's
	40's
	50's
	60's
	70's
	80's
	90's
	2000

PARKING STRUCTURE DESIGN GUIDELINES

Entry Signs

Emphasizing the entrance to a parking facility is important. Large illuminated signs are often used to emphasize the facility entry and attract patrons. These signs often spell out "Parking" or use the International symbol for parking. Architectural features, such as an arch, canopy, or some different treatment of the façade, are often used to highlight the entry area as well. A height clearance bar is required for all parking structures, including the top (surface) level of below-grade facilities to prohibit over-height vehicles. Generally, the height clearance bar is located at the facility entrance(s). There may be instances when the clear height in a parking structure changes from one level to another (for example, a higher ground level than typical level to accommodate ADA vans), which may require additional height clearance bars within the facility itself. Generally, the height clearance bar is an eight-inch PVC pipe.

Regulatory Signs

Regulatory signs are often used in parking facilities. Examples include "STOP," "YIELD," "ONE WAY," "NO PARKING" "DO NOT ENTER," and accessible parking signs. When used it is imperative that they comply with local and federal requirements. The Manual of Uniform Traffic Control Devices (MUTCD) provides examples of standard highway signs.



PARKING STRUCTURE DESIGN GUIDELINES

Illuminated Signs

Illuminated signs are becoming more and more common in parking facilities. Technology has advanced significantly in recent years and illuminated signs have become more reliable. Generally, illuminated signs are used for the following parking applications:

- Entry and Exit Lanes (Open in green/Closed in red)
- Facility Full Signs
- Stop (red)/Go (green)
- Level Space Capacity
- Directional Control
- Fee Display
- Space Count Systems
- Variable Message Signs

Pavement Markings

Pavement markings should conform to Manual of Uniform Traffic Control Devices (MUTCD) or local standards. MUTCD specifies that white paint be used for markings for traffic flow in the same direction and yellow paint used for traffic flow in opposite directions, which implies a warning.

Pavement markings can be an effective way to direct and control traffic flow in a parking facility. However, pavement markings must be re-applied due to wear and deterioration from vehicular traffic. Pavement arrows may enhance traffic flow. They are often utilized on surface lots or the top level of parking structures where overhead directional signage is not possible. Traffic arrows are also commonly used in facilities with a combination of one-way and two-way traffic flow.



PARKING STRUCTURE DESIGN GUIDELINES

Drainage

Proper floor drainage is essential for all types of parking structures in all climates. While direct rain or snow may not enter all areas of the parking garage, windblown rain and snow and/or vehicles carrying ice, snow and water will distribute water throughout the facility. Heavy rains will also overload top floor drains and water will run down the ramped floors to lower levels. In addition, the frequent floor wash downs that should be part of a good maintenance program are a source of water throughout the parking facility. If the floor is not adequately sloped, water is allowed to pond and deterioration will accelerate beneath the ponds.

A design slope of 2%, or $\frac{1}{4}$ inch per foot, is desired, with a minimum design slope of 1- $\frac{1}{2}$ %. Water should be drained away from exterior columns/walls and pedestrian paths. Washes may be needed in slab corners to achieve drainage slopes.

Floor drain locations are determined by the circulation system, number of bays, and structural system. The top level drain system should be designed to accept a 10-year design rainfall or as required by local code. Three to four inch piping is generally used on covered levels.

PARKING STRUCTURE DESIGN GUIDELINES

Open or Enclosed Parking Structure

Natural ventilation requires openings in exterior walls of sufficient size distributed in such a way that fresh air will enter the facility to disperse and displace contaminated air. The 2003 and 2006 International Building Code (IBC) states:

“For natural ventilation purposes, the exterior side of the structure shall have uniformly distributed openings on two or more sides. The area of such openings in exterior walls on a tier must be at least 20 percent of the total perimeter wall area of each tier. The aggregate length of the openings considered to be providing natural ventilation shall constitute a minimum of 40 percent of the perimeter of the tier. Interior walls shall be at least 20 percent open with uniformly distributed openings.”

“Exception: Openings are not required to be distributed over 40 percent of the building perimeter where the required openings are uniformly distributed over two opposing sides of the building.”

Setbacks can affect openness as firewalls are required if certain distance requirements from property lines and other buildings are not maintained. Parking structures are typically classified as enclosed if other uses (retail, office, residential) are located above the parking, but may remain open if parking is above or adjacent other uses. When a parking structure is positioned below grade, areaways can be used to achieve natural ventilation. The building code addresses the geometry required to permit acceptance of an areaway.

Parking structures classified as “open” do not require mechanical ventilation, fire suppression (sprinklers), and enclosed stairs.

“Enclosed”



- Enclosed Shafts
- Mechanical ventilation
- Increased illumination
- Increased fire rating
- Fire sprinklers



“Open”

- “Open” structures are allowed much larger floor plates and many more levels
- “Open” structures are naturally ventilated, so do not usually need mechanical ventilation
- “Open” structures do not require stairs to be enclosed
- “Open” structures allow a lot of natural light

PARKING STRUCTURE DESIGN GUIDELINES

Structural Systems

Following are the advantages and disadvantages of the three primary structural systems commonly used in parking structures today:

- *Cast-in-Place Concrete*
- *Precast Concrete*
- *Steel Framed*

The selection of the structural system should be given careful consideration. The decision is often made based on the following:

- Owner preference
- Design team preference
- Schedule
- Construction budget
- Openness and perceived headroom
- Owner's tolerance and budget for maintenance
- Local availability of product and labor



PARKING STRUCTURE DESIGN GUIDELINES

Cast-in-Place Concrete

Advantages of Cast-in-Place Construction:

- Monolithic construction so fewer sealant joints
- Positive drainage is easier to achieve
- Post-Tensioning forces reduces slab cracking
- Floor vibration imperceptible
- Flexible column spacing (20' to 27')
- Generally no shear walls
- Lower maintenance cost
- Wide beam spacing creates more open feeling with perception of higher ceiling
- Accommodates parking structures on irregular sites, beneath buildings, and underground

Disadvantages of Cast-in-Place Construction:

- Potentially higher construction cost
- Quality control is more difficult to attain due to exposed weather conditions
- May require architectural cladding to improve exterior aesthetics
- Less adaptable to winter construction in cold climates
- Longer on-site construction schedule
- Closer expansion joint spacing
- Congestion of tendons and rebar at beam column joints
- Larger on-site staging requirement



PARKING STRUCTURE DESIGN GUIDELINES

Precast Concrete

Advantages of Pre-Cast Construction:

- Quality control because members are fabricated at a plant
- Potentially lower construction cost in some regions
- Shorter on-site construction schedule
- Greater expansion joint spacing (up to 300 feet)
- More adaptable to winter construction
- Architectural façade spandrels also serve as structural load bearing elements

Disadvantages of Pre-Cast Construction:

- More propensity for leaking at the joints
- Higher maintenance cost for sealants
- The close spacing of the tee stems creates the perception of lower ceiling height
- Tee stems can block signage and interfere with lighting distribution
- Shear walls affect architecture at the exterior and reduce visibility at the interior
- Reduced drainage slopes
- More bird roosting ledges
- Might not be performed by local subcontractors



PARKING STRUCTURE DESIGN GUIDELINES

Steel Framed

Advantages of Steel Construction:

- Flexible column spacing of 18' to 22'
- Generally no shear walls
- Can be performed by local subcontractors
- Shorter on-site construction schedule
- Potentially lower construction cost
- Easily accommodates vertical expansion

Disadvantages of Steel Construction:

- Erection concerns due to mixing foundation, steel, and precast subcontractors
- Not recommended where the steel is required to be fire rated by the building code
- Depending upon code requirements, steel structure may need to be fireproofed
- Steel painting for corrosion protection
- Maintenance of steel paint system
- Steel delivery times can fluctuate
- Extensive bird roosting ledges on the beam flanges



PARKING STRUCTURE DESIGN GUIDELINES

Durability Design

It is recommended to perform an analysis in the schematic design phase to determine which durability elements should be included in the design of a parking structure. These elements include sealers, deck coatings, concrete additives, corrosion inhibitors, and epoxy coated reinforcement. Durable parking structures also require quality concrete (low water-to-cement ratio), adequate concrete cover, proper concrete curing, and good drainage. Tradeoffs between initial costs and long-term maintenance costs should be considered. Enhanced durability systems should be provided in areas with severe exposure, such as supported structure near vehicular entries and snow storage areas on the roof level. Deck coatings (membrane) are recommended over occupied space and over electrical and storage rooms.

The design of a parking structure should at a minimum conform to the intent of American Concrete Institute's Guide for the Design of Durable Parking Structures (ACI 362). The design life of a parking structure should be 60 years.



PARKING STRUCTURE DESIGN GUIDELINES

Other Considerations

There are other aspects of parking structure design that will not be specifically addressed but should be kept in mind, including:

- Zoning Requirements (permitted uses, setbacks, easements, etc.)
- Building Code Compliance
- Subsurface Conditions and Foundations
- Aesthetics
- Fire Rating, Fire Protection and Life Safety
- Mechanical Systems
- Storm Drainage and Water Storage
- Parking Access and Revenue Control Equipment
- Mixed Uses (retail, residential and office)
- Parking Office Requirements
- Maintenance

